



Product Specification

Model Name	LM070SWV07ES
Description	Standard LCD Module 7.0" WVGA 800x(RGB)x480 Dots
Date	2018/09/15
Version	1.0

- Preliminary Specification
- Final Product Specification

Prepared by	Checked by	Approved by
SXY 2018/09/15	SXY 2018/09/15	LX 2018/09/15

For Customer Approval

Approved By	Comment



深圳市美显实业有限公司 LCD Mall Limited

Table of Contents

1. Record of Revision	3
2. General Specifications	4
3. Input/OutputTerminals.....	5
4. Absolute Maximum Rating	6
5. Electrical Characteristics	6
6. Interface Timing	8
7. Optical Characteristics	13
8. Environmental / Reliability Tests.....	16
9. Mechanical Drawing	17
10. Packing.....	18
11. TFT-LCD Module Inspection Criteria	19
12. Precautions for Use of LCD modules.....	24



1. Record of Revision

Rev	Issued Date	Description	Editor
1.0	2018/09/15	First Release.	SXY



2. General Specifications

	Feature	Spec
Characteristics	Size	7.0 inch
	Resolution	800(horizontal)*480(Vertical)
	Interface	24-BIT RGB
	Pixel pitch (mm)	0.1926*0.1790
	Pixel Configuration	R.G.B.-Stripe
	LCD Driver IC	EK9713+EK73002
	CTP Driver IC	TBD
	Viewing Direction	12 O'CLOCK
Mechanical	LCM (W x H x D) (mm)	164.80*99.80*5.5
	Active Area(mm)	154.08*85.92
	With /Without TSP	Without TSP
	Weight (g)	TBD
	LED Numbers	30 LEDs

Note 1: Requirements on Environmental Protection: RoHs

Note 2: LCM weight tolerance: +/- 5%



3. Input/Output Terminals

LCD PIN-MAP

No.	Symbol	Description
1-2	LED+	Anode of LED backlight
3-4	LED-	Cathode of LED backlight
5	GND	Power ground
6	VCOM	Common voltage
7	DVDD	Power for digital circuit
8	MODE	DE/SYNC mode select
9	DE	Data input enable
10	VS	Vertical sync input
11	HS	Horizontal sync input
12-19	B7-B0	Blue data
20-27	G7-G0	Green data
28-35	R7-R0	Red data
36	GND	Power Ground
37	DCLK	Sample clock
38	GND	Power Ground
39	L/R	Left / right selection
40	U/D	Up/down selection
41	VGH	Gate ON Voltage
42	VGL	Gate OFF Voltage
43	AVDD	Power for Analog Circuit
44	RESET	Global reset pin
45	NC	No connection
46	VCOM	Common Voltage
47	DITHB	Dithering function
48	GND	Power Ground
49	NC	No connection
50	NC	No connection



4. Absolute Maximum Rating

Item	Symbol	MIN	MAX	Unit
Supply voltage for logic	DVDD	-0.3	5	V
Supply voltage for analog	AVDD	0.5	13.5	V
Power supply	VGH	0.3	40	
Power supply	VGL	-20	0.3	
Power supply	VGH-VGL		40	
Supply current (One LED)	I _{LED}		30	mA
Operating temperature	T _{OP}	-20	+70	°C
Storage temperature	T _{ST}	-30	+80	°C

Note: The absolute maximum rating values of this product are not allowed to be exceeded at any times. Should a module be used with any of the absolute maximum ratings exceeded, the characteristics of the module may not be recovered, or in an extreme case, the module may be permanently destroyed

5. Electrical Characteristics

5.1 Input Power

Item	Symbol	Min	Typ	Max	Unit	Applicable terminal
Supply Voltage for Analog	DVDD	3.0	3.3	3.6	V	
Supply Voltage for Logic	AVDD	10.2	10.4	10.6	V	
Power supply	VGH	15.3	16	16.7		
Power supply	VGL	-7.7	-7	-6.3		
Power supply	VCOM	2.6	3.6	4.6		
Input Voltage	V _{IL}	GND	-	0.3DVDD	V	
	V _{IH}	0.7DVDD	-	DVDD		
Input leakage Current	I _{LKG}	-	-	-	uA	

5.2 Backlight Driving Conditions

Item	Symbol	Value			Unit	Remark
		Min	Typ	Max		
Voltage for LED Backlight	V _F	8.4	9.3	10.2	V	I _L =225mA
Current for LED Backlight	I _L		225		mA	
Power Consumption	P		2.092		W	
LED Life Time		30,000	50,000		Hr	Note

Note: Brightness to be decreased to 50% of the initial value at ambient temperature TA=25°C

5.3 Block Diagram

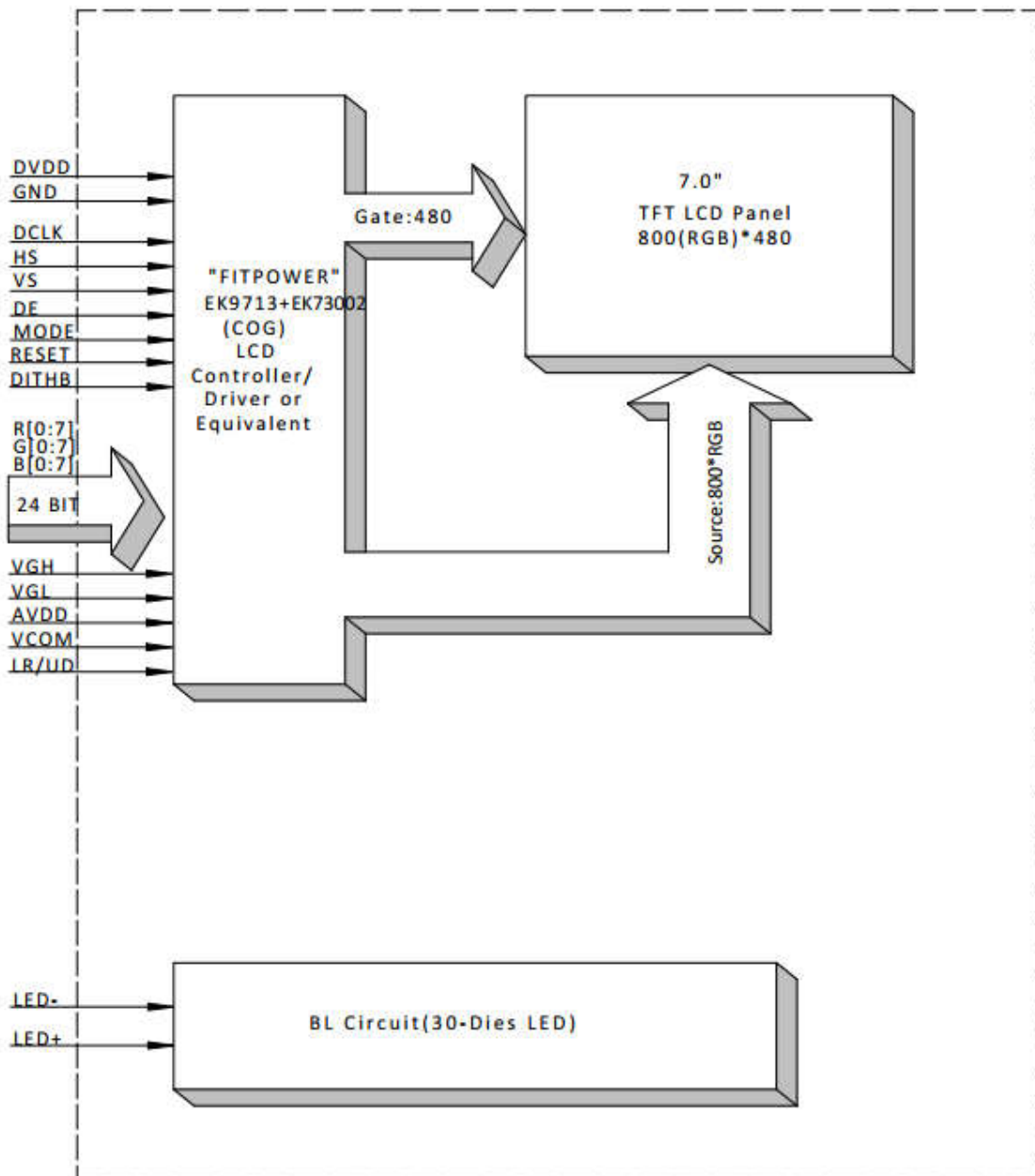

6. Interface Timing

6.1 POWER SEQUENCE

In order to prevent IC from power on reset fail, the rising time (TPOR) of the digital power supply VDD should be maintained within the given specifications. Refer to "AC Characteristics" for more detail on timing.

This is another paragraph of sub-function description.

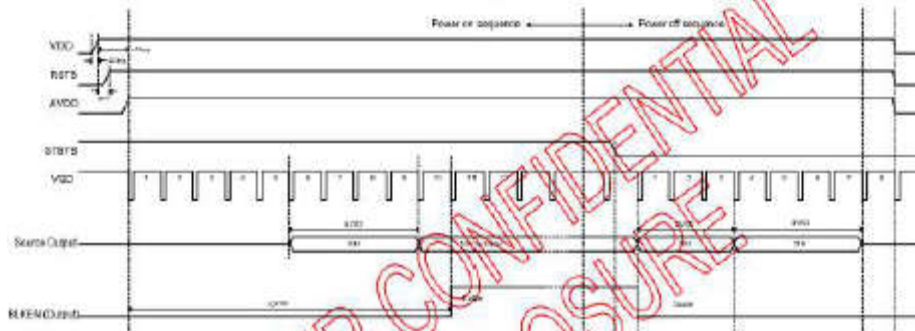

Power-On/Off Timing Sequence

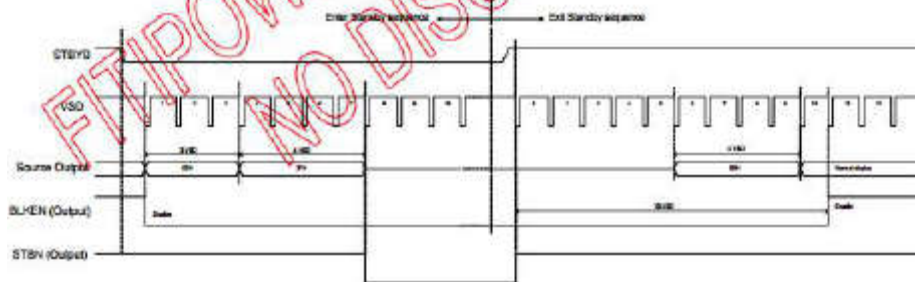

Enter and Exit Standby Mode Sequence

Power on

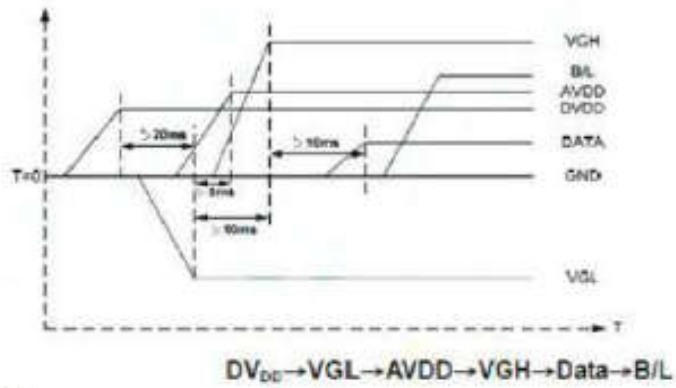

Power off

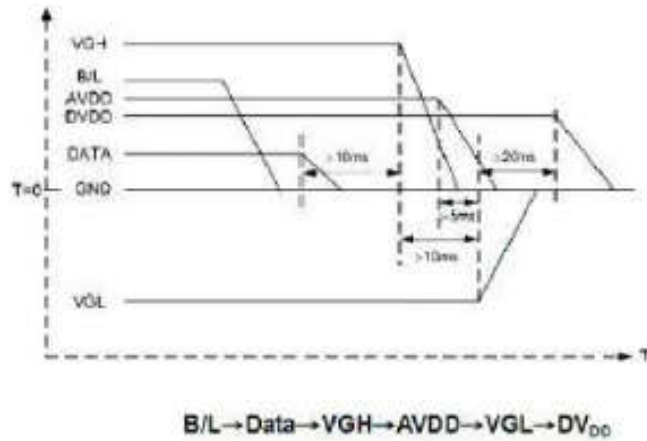

6.2 Data input format

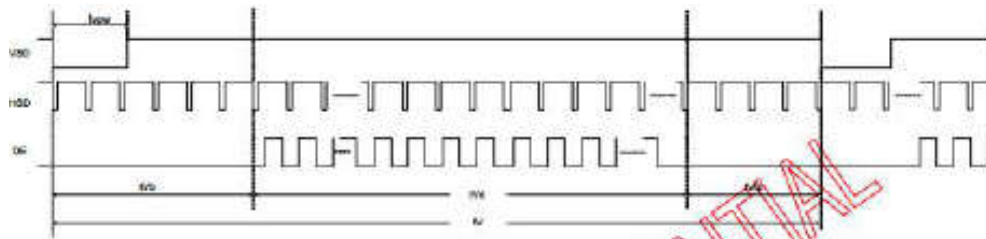

Vertical input timing

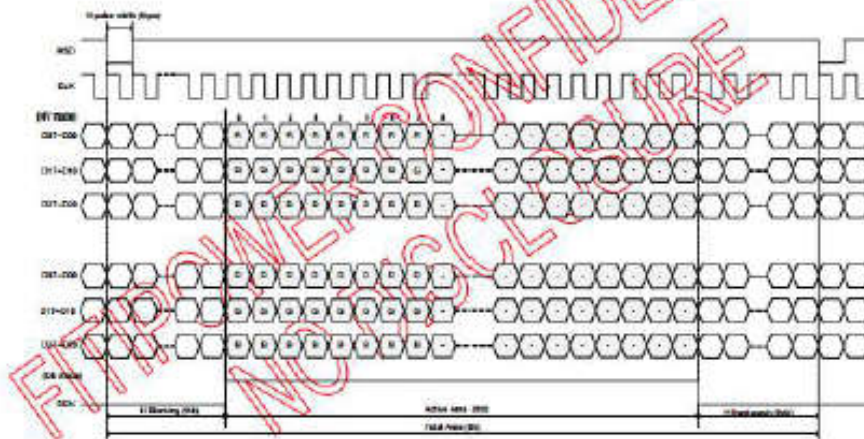

Horizontal input timing

6.3 RGB MODE TIMING DIAGRAM

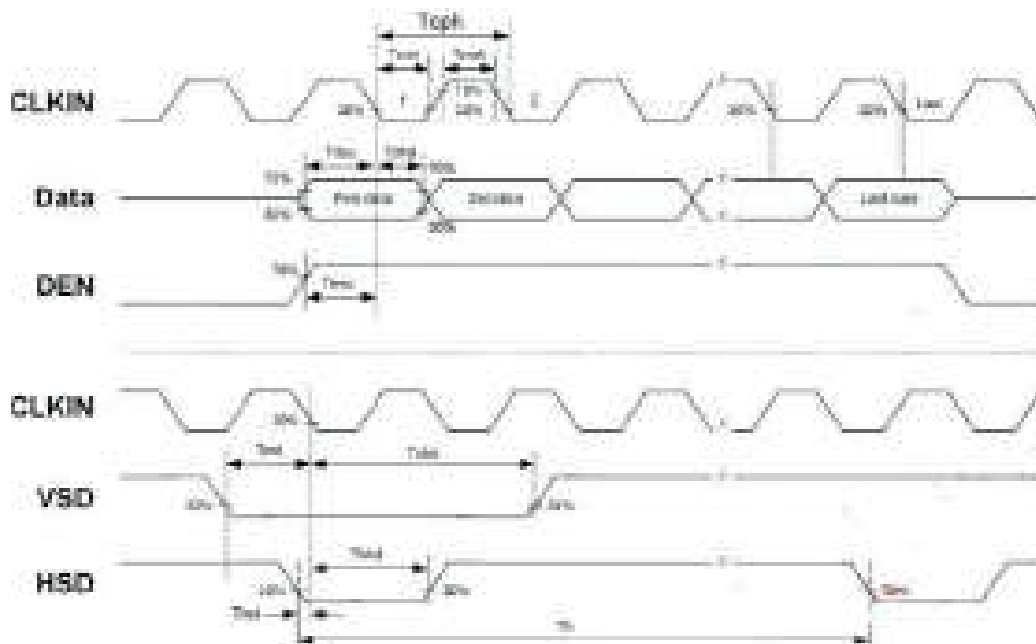

6.4 TIMING Characteristic

Item	Symbol	Values			Unit	Remark
		Min.	Typ.	Max.		
Horizontal Display Area	thd		800		DCLK	
DCLK Frequency	fdck	26.3	33.3	46.8	MHz	
One Horizontal Line	th	862	1056	1200	DCLK	
HS pulse width	thpw	1	-	40	DCLK	
HS Blanking	thb	46	46	46	DCLK	
HS Front Porch	thfp	16	210	354	DCLK	

Item	Symbol	Values			Unit	Remark
		Min.	Typ.	Max.		
Vertical Display Area	tvd		480		TH	
VS period time	tv	510	625	650	TH	
VS pulse width	tvpw	1		20	TH	
VS Blanking	tvb	23	23	23	TH	
VS Front Porch	tvfp	7	22	147	TH	

6.5 Timing waveform

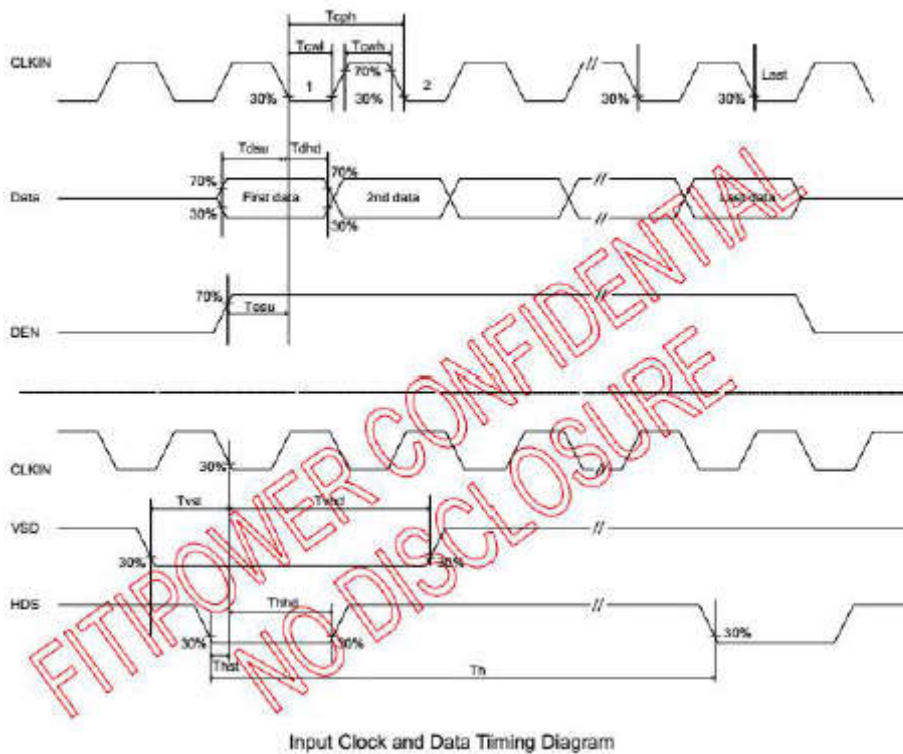

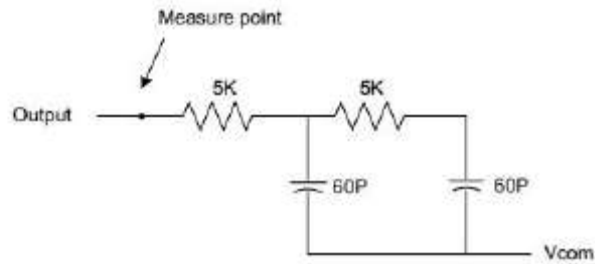

Output load condition

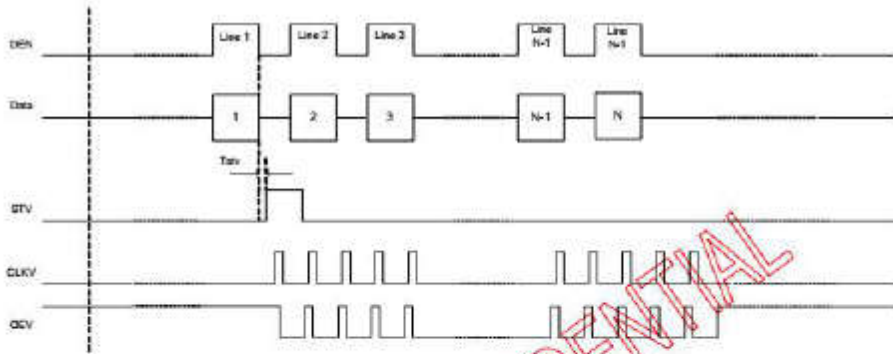

Vertical Timing Diagram DE

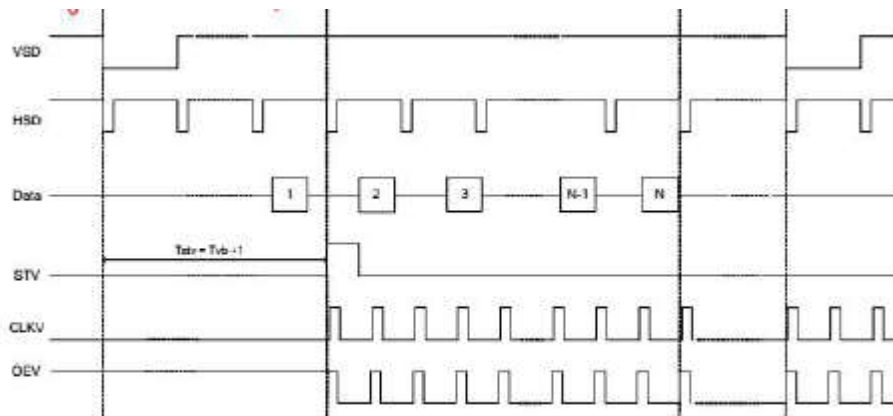

Vertical Timing Diagram HV

7. Optical Characteristics

ITEM	SYMBOL	CONDITIONS	SPECIFICATIONS			UNIT	NOTE
			MIN	TYP	MAX		
Luminance	L	IL=225mA	800	1000	1200	Cd/m ²	
Contrast Ratio	CR	$\theta=0^\circ$	400	500			
Response Time	T _{ON}	25°C		10	20	ms	
	T _{OFF}			15	30		
CIE Color Coordinate	Red	X _R	Viewing normal angle	0.554	0.574	0.594	
		Y _R		0.339	0.359	0.379	
	Green	X _G		0.322	0.342	0.362	
		Y _G		0.563	0.583	0.60	
	Blue	X _B		0.125	0.145	0.162	
		Y _B		0.091	0.111	0.131	
	White	X _W		0.296	0.316	0.336	
		Y _W		0.336	0.356	0.376	
Viewing Angle	Hor	θ_{x+}	CR ≥ 10	60	70	Degree	Gray Scale inversion
		θ_{x-}		60	70		
	Ver	θ_{y+}		40	50		
		θ_{y-}		60	70		
Uniformity	Un			70	75	%	

Note1. Definition of contrast ratio

Contrast ratio(Cr) is defined mathematically by the following formula. For more information see FIG.2.

$$\text{Contrast ratio} = \frac{\text{Luminance measured when LCD on the "White" state}}{\text{Luminance measured when LCD on the "Black" state}}$$

For contrast ratio, Surface Luminance, Luminance uniformity and CIE, the testing data is based on TOPCON's BM-5 or BM-7 photo detector or compatible.

Note2. Definition of surface luminance.

Surface luminance is the luminance with all pixels displaying white. For more information see FIG.2.

$$L_v = \text{Average Surface Luminance with all white pixels}(P_1, P_2, P_3, \dots, P_n)$$

Note3. Definition of luminance uniformity

The luminance uniformity in surface luminance is determined by measuring luminance at each test position 1 through n, and then dividing the maximum luminance of n points luminance by minimum luminance of n points luminance. For more information see FIG.2.

$$Y_U = \frac{\text{Minimum surface luminance with all white pixels } (P_1, P_2, P_3, \dots, P_n)}{\text{Maximum surface luminance with all white pixels } (P_1, P_2, P_3, \dots, P_n)}$$

Note4. Definition of response time

The response time is defined as the LCD optical switching time interval between “White” state and “Black”state. Rise time (T_r) is the time between photo detector output intensity changed from 90% to 10%. And fall time (T_f) is the time between photo detector output intensity changed from 10% to 90%.

For additional information see FIG1.

Note5. Definition of color chromaticity (CIE1931)

CIE (x,y) chromaticity, The x,y value is determined by screen active area center position P5. For more information see FIG.2.

Note6. Definition of viewing angle

Viewing angle is the angle at which the contrast ratio is greater than 10. Angles are determined for the horizontal or x axis and the vertical or y axis with respect to the z axis which is normal to the LCD surface. For more information see FIG.3.

For viewing angle and response time testing, the testing data is base on Autronic-Melchers’s ConoScope or DMS series Instruments or compatible.

FIG.1. The definition of response Time

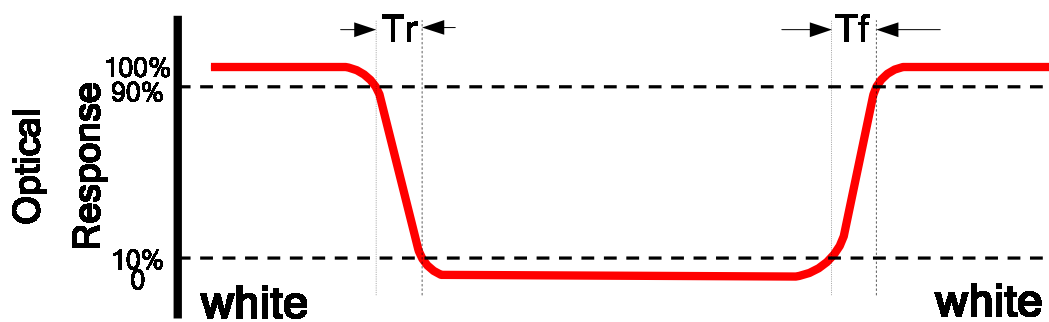

FIG.2. Measuring method for contrast ratio, surface luminance,

luminance uniformity, CIE (x,y) chromaticity

Size : $S \leq 5''$ (see Figure a) A : 5 mm B : 5 mm

H,V : Active area

Light spot size $\phi=5\text{mm}$ (BM-5) or $\phi=7.7\text{mm}$ (BM-7) 50cm distance or compatible distance from the LCD surface to detector lens.

test spot position : see Figure a.

measurement instrument : TOPCON’s luminance meter BM-5 or BM-7 or compatible (see Figure c).

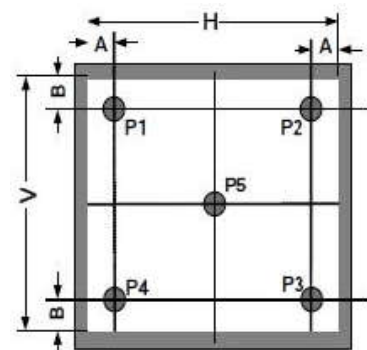

Figure a

Size : 5" $S \le 12.3''$(see Figure b) H,V : Active area

Light spot size $\phi=5\text{mm}$ (BM-5) or $\phi=7.7\text{mm}$ (BM-7)50cm distance or compatible distance from the LCD surface to detector lens.

test spot position : see Figure b.

measurement instrument : TOPCON's luminance meter BM-5 or BM-7 or compatible (see Figure c).

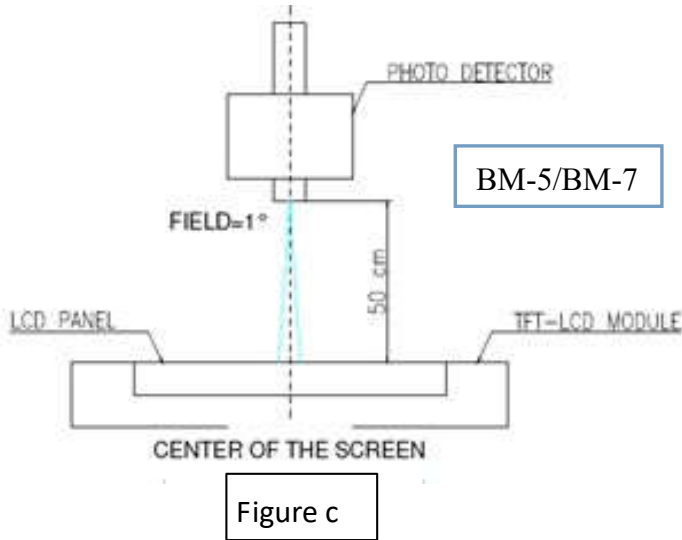
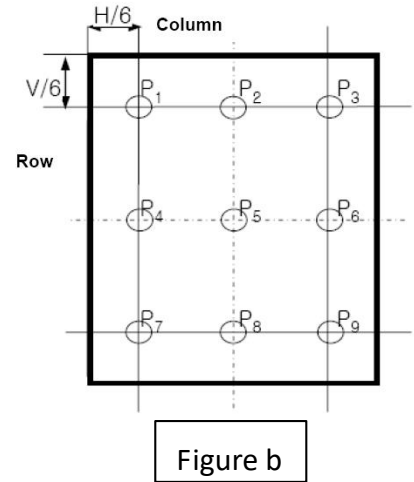
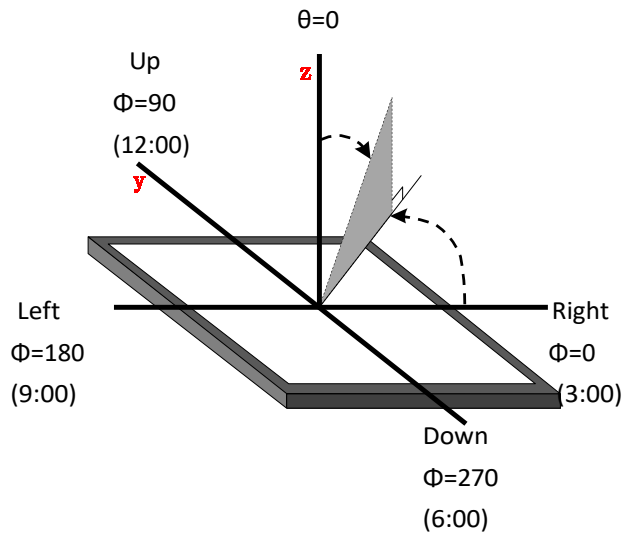

FIG.3.The definition of viewing angle



8. Environmental / Reliability Tests

No	Test Item	Condition	Remarks
1	High Temperature Operation	Ts= +70°C, 240hrs	Note 1 IEC60068-2-2, GB2423.2-89
2	Low Temperature Operation	Ta= -20°C, 240hrs	Note 2 IEC60068-2-1 GB2423.1-89
3	High Temperature Storage	Ta= +80°C, 240hrs	IEC60068-2-2 GB2423.2-89
4	Low Temperature Storage	Ta= -30°C, 240hrs	IEC60068-2-1 GB/T2423.1-89
5	High Temperature & Humidity Storage	Ta= +60°C, 90% RH max, 240 hours	IEC60068-2-3 GB/T2423.3-2006
6	Thermal Shock (Non-operation)	-30°C 30 min ~ +80°C 30 min Change time: 5min, 20 Cycle	Start with cold temperature, end with high temperature IEC60068-2-14, GB2423.22-87
7	Electro Static Discharge (Operation)	C=150pF, R=330 Ω, 5 points/panel Air:±8KV, 5 times; Contact: ±4KV, 5 times; (Environment: 15°C ~ 35°C, 30% ~ 60%, 86Kpa ~ 106Kpa)	IEC61000-4-2 GB/T17626.2-1998
8	Vibration (Non-operation)	Frequency range: 10~55Hz, Stroke: 1mm Sweep: 10Hz~55Hz~10Hz 2 hours for each direction of X .Y. Z. (package condition)	IEC60068-2-6 GB/T2423.5-1995
9	Shock (Non-operation)	60G 6ms, ± X, ±Y, ± Z 3 times for each direction	IEC60068-2-27 GB/T2423.5-1995
10	Package Drop Test	Height: 80 cm, 1 corner, 3 edges, 6 surfaces	IEC60068-2-32 GB/T2423.8-1995

- Note: 1. Ts is the temperature of panel's surface.
2. Ta is the ambient temperature of sample.
3. The size of sample is 5pcs.

9. Mechanical Drawing

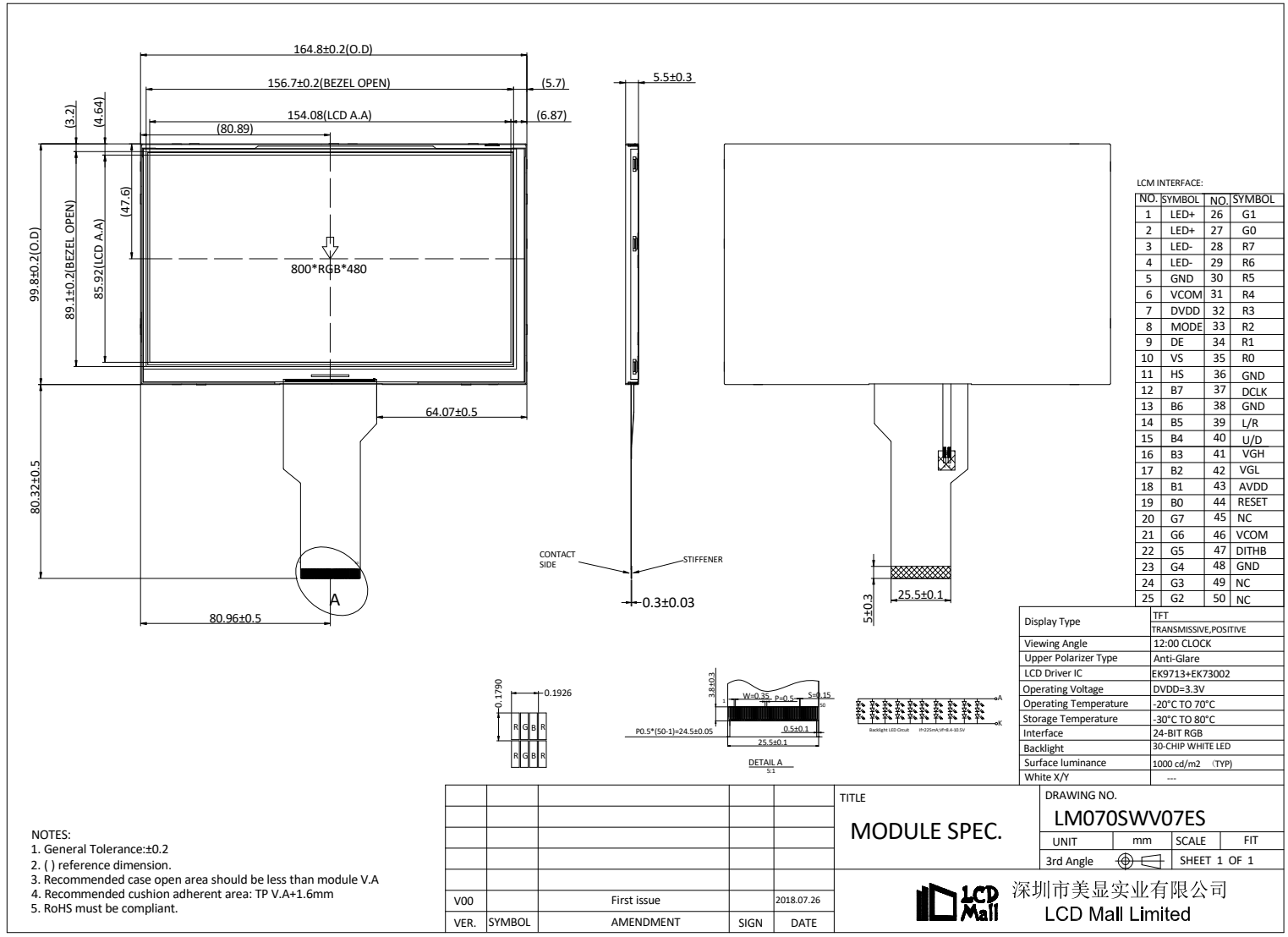

10. Packing

Packing Method

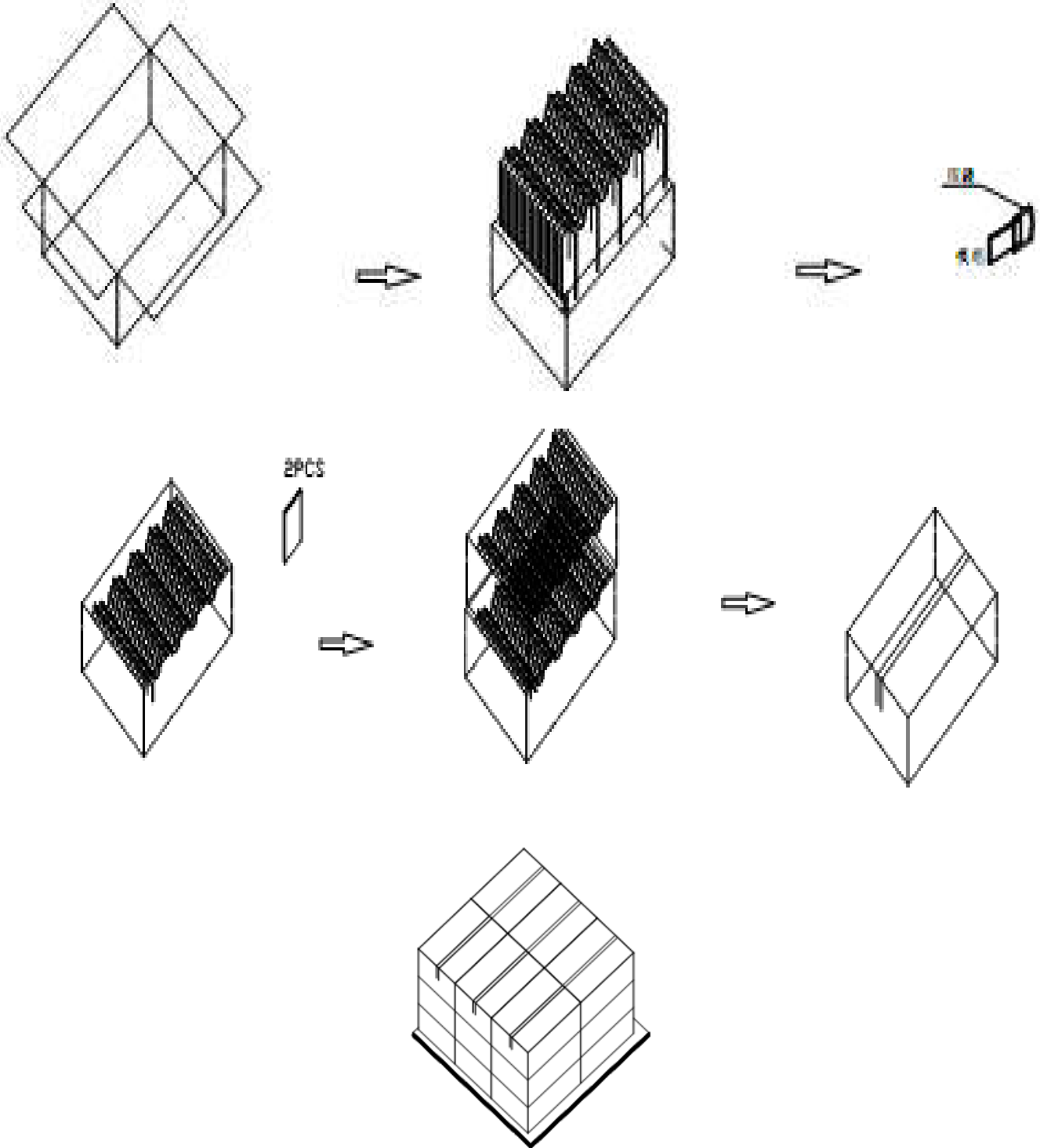

11. TFT-LCD Module Inspection Criteria

11.1 Scope

The incoming inspection standards shall be applied to TFT –LCD Modules (hereinafter Called "Modules") that supplied by LCD Mall Limited.

11.2 Incoming Inspection

The customer shall inspect the modules within twenty calendar days of the delivery date (the inspection period) at its own cost. The result of the inspection (acceptance or rejection) shall be recorded in writing, and a copy of this writing will be promptly sent to The seller, If the results of the inspecting from buyer does not send to the seller within twenty Calendar days of the delivery date. The modules shall be regards as acceptance.

Should the customer fail to notify the seller within the inspection period, the buyers Right to reject the modules shall be lapsed and the modules shall be deemed to have Been accepted by the buyer

11.3 Inspection Sampling

- 3.1. Lot size: Quantity per shipment lot per model
 - 3.2. Sampling type: Normal inspection, Single sampling
 - 3.3. Inspection level: II
 - 3.4. Sampling table: MIL-STD-105E
 - 3.5. Acceptable quality level (AQL)
- Major defect: AQL=0.65 Minor defect: AQL=1.00

11.4 Inspection Conditions

4.1 Ambient conditions:

- a. Temperature: Room temperature $25\pm 5^{\circ}\text{C}$
- b. Humidity: $(60\pm 10)\% \text{RH}$
- c. Illumination: Single fluorescent lamp non-directive (300 to 700 Lux)

4.2 Viewing distance

The distance between the LCD and the inspector's eyes shall be at least $35\pm 5 \text{ cm}$.

4.3 Viewing Angle

U/D: $45^{\circ}/45^{\circ}$, L/R:

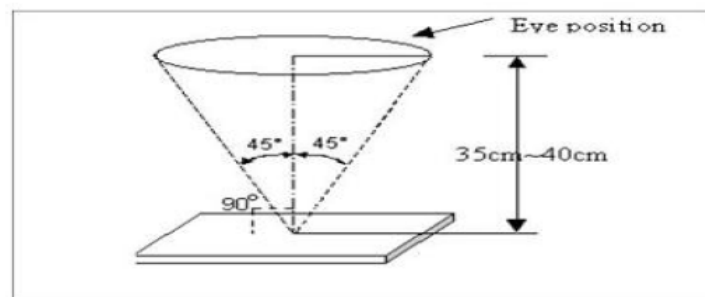

$45^{\circ}/45^{\circ}$

11.5 Inspection Criteria



Defects are classified as major defects and minor defects according to the degree of Defectiveness defined herein.

11.5.1 Major defect

Item No	Items to be inspected	Inspection Standard
5.1.1	All functional defects	1) No display 2) Display abnormally 3) Short circuit 4) line defect
5.1.2	Missing	Missing function component
5.1.3	Crack	Glass Crack

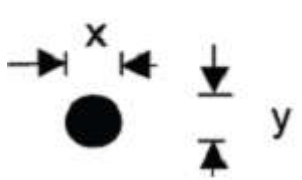
11.5.2 Minor defect

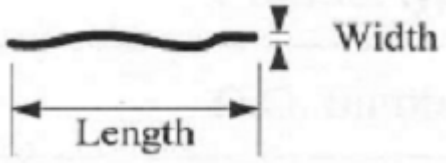
Item No	Items to be inspected	Inspection standard	
5.2.1	Spot Defect Including Black spot White spot Pinhole Foreign particle Polarizer dirt	For dark/white spot is defined $\phi = (x+y) / 2$ 	
		Size ϕ (mm)	Acceptable Quantity
		$\phi \leq 0.2$	Ignore
		$0.2 < \phi \leq 0.5$	3
		$0.5 < \phi$	Not allowed

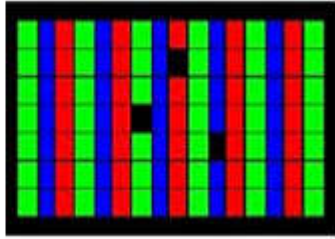
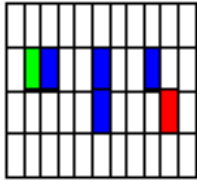
5.2.2	Line Defect Including Black line White line Scratch	Define: 			
		Width(mm) Length(mm)		Acceptable Quantity	
		W≤0.05		Ignore	
		0.05 < W≤0.1 L≤2.5		3	
		0.1 < W, or L>2.5		Not allowed	
5.2.3	Polarizer Dent/Bubble	Sizeφ(mm)		Acceptable Quantity	
		φ≤0.2		Ignore	
		0.2 < φ≤0.3		2	
		0.3 < φ≤0.5		1	
		0.5 < φ		Not allowed	
		Total QTY		3	
5.2.4	Electrical Dot Defect	Bright and Black dot define:  and 			
		 Two Adjacent Dot			
		Inspection pattern: Full white、Full black、Red、green and blue screens			
		Item		Acceptable Quantity	
		Black dot defect		I	O
		2			

		Bright dot defect	1	(5mm≤Distance)
		Two Adjacent Dot	1	
		There or more Adjacent Dot	Not allowed	
		Total Dot	2	
5.2.5	Glass defect	<p>1. Corner Fragment:</p>		
		Size(mm)	Acceptable Quantity	
		X≤3mm Y≤1mm Z≤T	Ignore T: Glass thickness X: Length Y: Width Z: thickness	
		<p>2. Side Fragment:</p>		
		Size(mm)	Acceptable Quantity	
X≤5.0mm Y ≤1mm Z≤T	T: Glass thickness X: Length Y: Width Z: thickness			

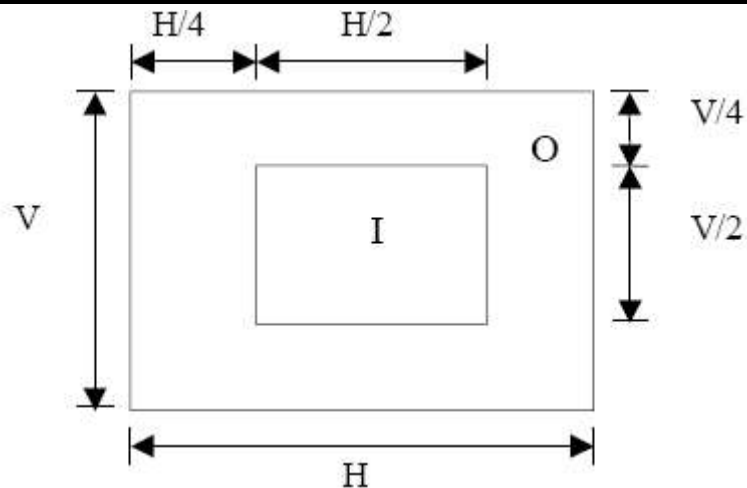



I area & O area

- Note:
- 1). Dot defect is defined as the defective area of the dot area is larger than 50% of the dot area.
 - 2). The distance between two bright dot defects (red, green, blue, and white) should be larger than 15mm.
 - 3). The distance between black dot defects or black and bright dot defects should be more than 5mm apart.
 - 4). Polarizer bubble is defined as the bubble appears on active display area. The defect of polarizer bubble shall be ignored if the polarizer bubble appears on the outside of active display area.

11.6 Mechanics specification

As for the outside dimension, weight of the modules, please refer to product specification
For more details



12. Precautions for Use of LCD modules

12.1 Handling Precautions

12.1.1. The display panel is made of glass. Do not subject it to a mechanical shock by dropping it from a high place, etc.

12.1.2. If the display panel is damaged and the liquid crystal substance inside it leaks out, be sure not to get any in your mouth, if the substance comes into contact with your skin or clothes, promptly wash it off using soap and water.

12.1.3. Do not apply excessive force to the display surface or the adjoining areas since this may cause the color tone to vary.

12.1.4. The polarizer covering the display surface of the LCD module is soft and easily scratched. Handle this polarizer carefully.

12.1.5. If the display surface is contaminated, breathe on the surface and gently wipe it with a soft dry cloth. If still not completely clear, moisten cloth with one of the following solvents:

Isopropyl alcohol & Ethyl alcohol

Solvents other than those mentioned above may damage the polarizer. Especially, do not use the following: Water & Ketene & Aromatic solvents

12.1.6. Do not attempt to disassemble the LCD Module.

12.1.7. If the logic circuit power is off, do not apply the input signals.

12.1.8. To prevent destruction of the elements by static electricity, be careful to maintain an optimum work environment.

12.1.8.1. Be sure to ground the body when handling the LCD Modules.

12.1.8.2. Tools required for assembly, such as soldering irons, must be properly ground.

12.1.8.3. To reduce the amount of static electricity generated, do not conduct assembly and other work under dry conditions.

12.1.8.4. The LCD Module is coated with a film to protect the display surface. Be care when peeling off this protective film since static electricity may be generated.

12.2 Storage Precautions

12.2.1. When storing the LCD modules, avoid exposure to direct sunlight or to the light of fluorescent lamps.

12.2.2. The LCD modules should be stored under the storage temperature range. If the LCD modules will be stored for a long time, the recommend condition is:

Temperature : 0°C ~ 40°C Relatively humidity: ≤80%

12.2.3. The LCD modules should be stored in the room without acid, alkali and harmful gas.

12.3 Transportation Precautions

The LCD modules should be no falling and violent shocking during transportation, and also should avoid excessive press, water, damp and sunshine.